

CL17 CHLORINE ANALYZER



Applications

- Beverage
- Collection Systems
- Drinking Water
- Field Use
- Food QC Lab
- Pharmaceutical
- Power
- Semiconductor
- Wastewater

Dependable, colorimetric DPD free or total chlorine analysis.

Accurate, Reliable Results

The Hach CL17 Chlorine Analyzer uses colorimetric DPD chemistry to monitor water continuously for free or total residual chlorine. The CL17 analysis method is not affected by changes in chlorine concentration, sample pH, temperature, flow or pressure, thus offering more accuracy than other methods in today's market.

Simple, Predictable Maintenance

Monthly routine maintenance for the CL17 can usually be performed in 15 minutes, including changing reagents and cleaning the colorimetric cell. No special tools are required. For typical use, the CL17 will operate unattended for 30 days. Challenging applications may require more frequent cleaning.

Factory Calibrated

The CL17 Chlorine Analyzer is factory calibrated. A built-in electronic calibration curve is preprogrammed into the instrument. This instrument does not require recalibration unless specified by your regulatory agency for compliance reporting purposes.

EPA Compliant

The CL17 is compliant with US EPA regulation 40 CFR 140.74. Both Method 4500-CL G and Method 334.0 can be used for measuring residual chlorine in drinking water.



Be Right™

Specifications*

Range	0 to 5 mg/L free or total residual chlorine
Accuracy	± 5 % or ±0.03 mg/L (ppm) as Cl ₂ , whichever is greater
Lower Limit of Detection (LOD)	0.03 mg/L (ppm)
Cycle Time	2.5 minutes
Inlet Pressure	1 to 5 psig (0.07 to 0.34 bar), .5 psi is optimum
Pressure Limit	Inlet Pressure to Sample Conditioning: 1.5 to 75 psi (0.1 bar to 5.2 bar)
Inlet	1/4-inch OD polyethylene tube, quick-disconnect fitting
Drain	1/2-inch ID flexible hose, hose barb
Air Purge	0.1 cfm (0.17 m ³ /h) instrument quality air at max. 20 psig (ca. 1.4 bar) with 1/4-inch OD tube, quick disconnect fitting
Sample Flow Rate	200 to 500 mL per minute minimum
Sample Temperature	5 to 40 °C (41 to 104 °F)
Operating Temperature Range	5 to 40 °C (41 to 104 °F)
Operating Humidity	Up to 90% at 40 °C (104 °F) maximum
Interferences	Other oxidizing agents such as bromide, chlorine dioxide, permanganate and ozone will cause a positive interference. Hexavalent chromium will cause a positive interference: 1 mg/L Cr ⁶⁺ = approximately 0.02 mg/L as Cl ₂ . Hardness must not exceed 1,000 mg/L as CaCO ₃ .
Recorder Outputs	One 0/4-20 mA with an output span programmable over any portion of the 0 to 5 mg/L range. Recommended load impedance 3.6 to 500 ohms, 130 V isolation from earth ground.

Alarm	Two alarms selectable for sample concentration alarm, analyzer system warning, or analyzer system shut-down alarm. Each is equipped with an SPDT relay with contacts rated for 5A resistive load at 230 V AC.
Certifications	Europe, CE Approved with: EN 61326-1 CISPR 11 EN 61010-1 IEC 60529 North America: UL 61010A-1 CAN/CSA C22.2 No. 1010.1-92
Power Requirements (Voltage)	100 - 115/230 V AC
Power Requirements (Amps)	2.5 A
Power Requirements (Hz)	50/60 Hz
Display	LCD, 3-1/2 inch digit measurement readout and six-character alphanumeric scrolling text line
Light Source	Class 1 LED (light emitting diode) with a peak wavelength of 520 nm; 50,000 hours estimated minimum life
Enclosure Construction	ABS plastic, two clear polycarbonate windows, IP62-rated with the gasketed door latched.
Mounting Style	Wall mount
Dimensions Metric (H x W x D)	454 mm x 314 mm x 179 mm
Weight	23.13 lbs. (10.49 kg)

*Subject to change without notice.

Principle of Operation

The CL17 Chlorine Analyzer has three operating components:

- A linear peristaltic pump to precisely control the volume of incoming samples and reagents.
- A colorimeter with seal-free, solid-state mixing system that includes a self-cleaning stir bar.
- One-month supply of reagents (indicator and buffer)

A zero reference point is established with the first sample in the cycle by measuring blank absorbance. (This compensates for the sample's color intensity and turbidity before the chlorine measurement is made.) Then, indicator and buffer reagents are added to the sample while a magnetic stirrer mixes the solution and the sample changes color. A compact colorimeter then measures the light transmitted through the sample. The measured color intensity is compared to a reference standard. Finally, the sample cell is flushed with new sample so that the cycle can repeat itself every 2.5 minutes.

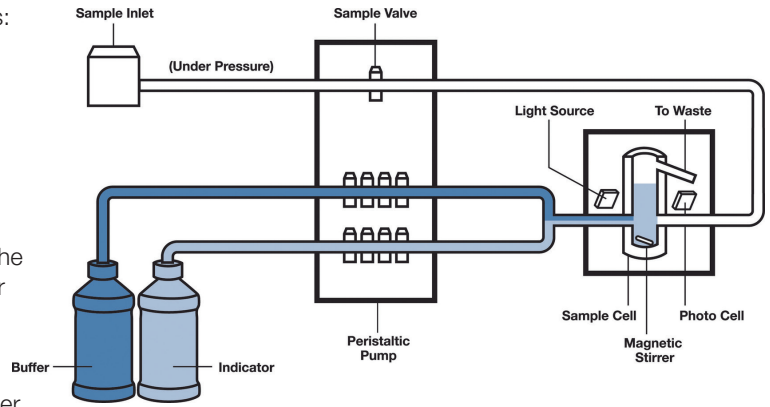

Dimensions

The CL17 is designed to be wall-mounted with four 1/4-inch screws. Adequate clearance must be left at the sides and bottom of the case for plumbing and electrical connections. The sample inlet connection is 1/4-inch quick-disconnect fitting and the drain connection is 1/2-inch I.D. flexible hose. Electrical connections are inside the instrument case. Holes for three 1/2-inch conduit fittings are provided.

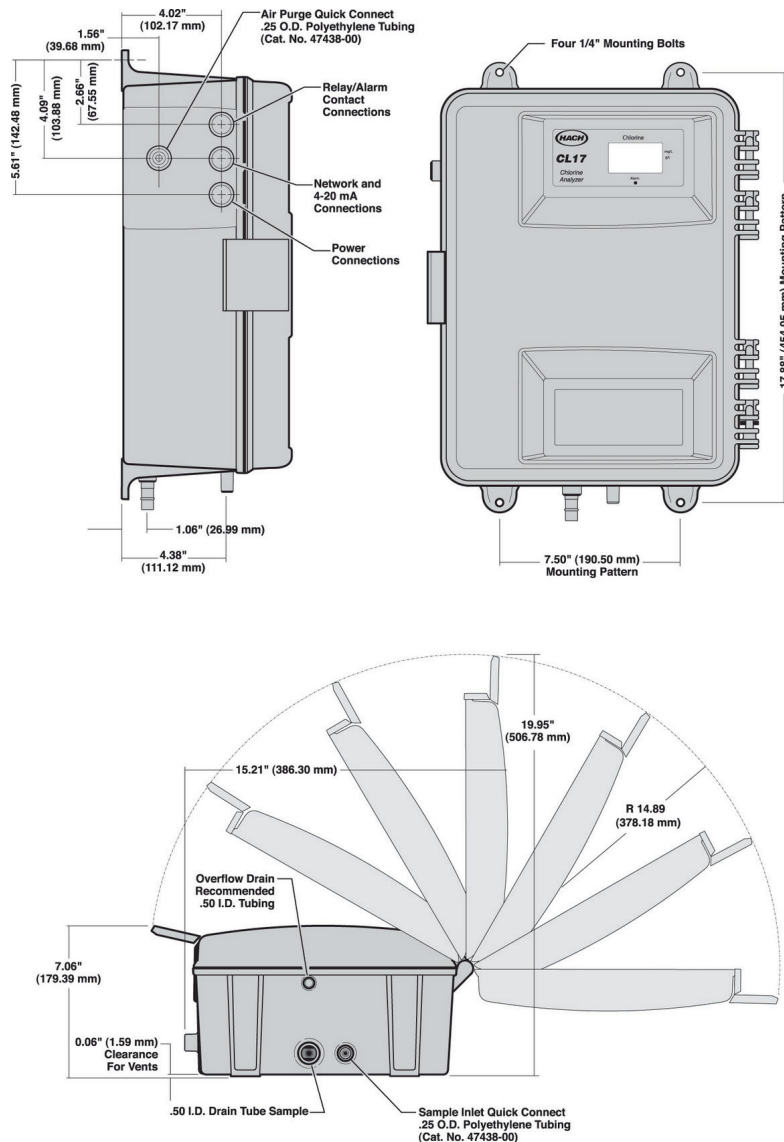

Ordering Information

Hach CL17 Chlorine Analyzers are shipped with a one-month supply of reagents, maintenance kit, installation kit, and manual. (The power cord is ordered separately.)

- 5440001** Model CI17 Free Residual Chlorine Analyzer
- 5440002** Model CI17 Total Residual Chlorine Analyzer
- 5440003** Model CI17 Free Residual Chlorine Analyzer with AquaTrend® Network Capability
- 5440004** Model CI17 Total Residual Chlorine Analyzer with AquaTrend® Network Capability

Accessories

- 5448800** North American Power Cord Kit with Strain Relief, 125V
- 5448900** European Power Cord Kit with Strain Relief, 230V
- 5444300** Maintenance Kit, 1 year, includes tubing, caps, funnel, and fittings
- 5444301** Maintenance kit, 1 year, includes preassembled tubing, caps, funnel, and fittings.
- 4643600** Sample Inlet Flow Meter
- 5449000** CI17 Calibration/Verification Kit

Reagents

Reagents

- 2556900** Free Chlorine Reagent Set
- 2557000** Total Chlorine Reagent Set
- 2297255** CI17 DPD Indicator Powder (Free and Total)
- 2314011** CL17 Free Chlorine Indicator Solution
- 2314111** CL17 Free Chlorine Buffer Solution
- 2263411** CL17 Total Chlorine Indicator Solution
- 2263511** CL17 Total Chlorine Buffer Solution



HACH COMPANY World Headquarters: Loveland, Colorado USA

United States: 800-227-4224 tel 970-669-2932 fax orders@hach.com
 Outside United States: 970-669-3050 tel 970-461-3939 fax int@hach.com
hach.com

LIT1626 Rev 6

C14 Printed in U.S.A.

©Hach Company, 2014. All rights reserved.

In the interest of improving and updating its equipment,

Hach Company reserves the right to alter specifications to equipment at any time.



Be Right™